

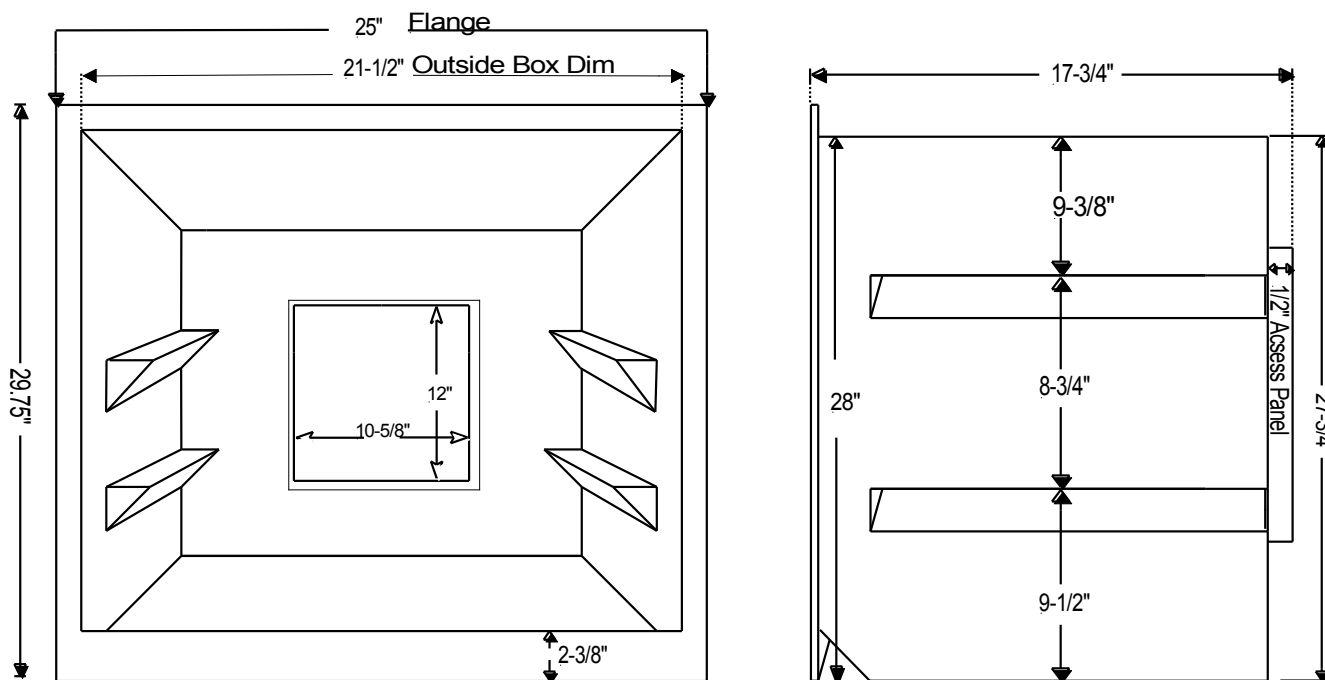

SCIENTIFIC PLASTICS INC.

Universal One Piece Cabinet Liner - 24Tall



Liner designed to fit cabinets with openings
28"-29-3/4"(H) X 21-1/2"-25"(W).

- Due to rotational molding variability all measurements are $\pm 1/8"$.
- Liner is manufactured to sit on bottom of cabinet with bottom flange flush to cabinet.
- Only top and side flanges should be trimmed to fit cabinet.
DO NOT TRIM BOTTOM FLANGE.
- Liner must be secured to inside of cabinets with proper fasteners. Minor shimming may be required for secure and level installation.
- Cabinets should be kept at an ambient temp of $70^{\circ}\text{F} \pm 5^{\circ}$ for at least 24 hours prior to on-sight trimming and installation.



Scientific Plastics Inc.
1016 Southwest Blvd.
Kansas City Ks. 66103
Phone:(913)432-0322
Fax:(913)432-0459

S.P. Part Number RO24TALL-001

Date: 2/22/12